

# UNDERSTANDING YOUR VEHICLE'S SAFETY EQUIPMENT

What every driver  
and passenger  
should know



**THIS BOOKLET WAS PREPARED TO ANSWER QUESTIONS ABOUT SEAT BELTS, AIRBAGS, AND OTHER SAFETY EQUIPMENT IN NEWER HONDA AND ACURA VEHICLES. PLEASE TAKE A FEW MOMENTS TO READ IT, BECAUSE WE BELIEVE THE MORE YOU UNDERSTAND HOW YOUR SAFETY EQUIPMENT WORKS, THE SAFER YOU AND YOUR PASSENGERS WILL BE. SINCE SOME EQUIPMENT MAY NOT BE IN A SPECIFIC MODEL, BE SURE TO CONSULT YOUR OWNER'S MANUAL.**

## WHAT ARE YOUR RISKS?

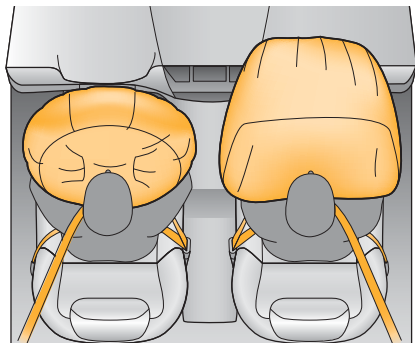

Your vehicle is equipped with seat belts, front airbags, and other equipment to help protect occupants during a crash.

**DID YOU KNOW** that every 12 seconds someone in the U.S. is injured in a vehicle crash? While some collisions can't be avoided, there is much you can do to help reduce the severity of injuries in a crash.

The most important thing is to always wear your seat belt. A properly worn seat belt is your first line of defense in all types of collisions.

Airbags are another part of your vehicle's occupant protection system, and they can also help protect you. But airbags are designed to work with, not replace, seat belts. So be sure you and any passengers in your vehicle always "buckle up."

# HOW YOU CAN BE HURT IN A FRONTAL CRASH

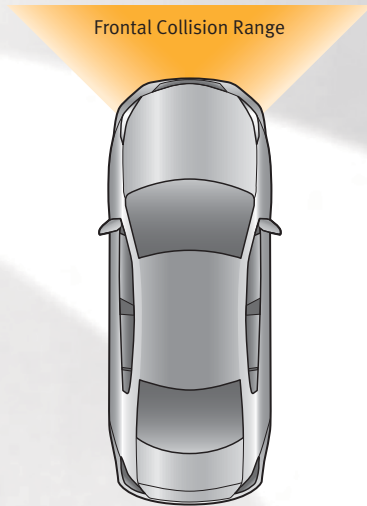

---

Frontal crashes account for more than half of all crash injuries that result in death.

## FRONTAL COLLISIONS

are the most common type of crash, and they result in more deaths and injuries than side impacts, rear impacts, and rollovers combined.

The risk of injury generally increases with speed, but speed itself does not cause injuries. Instead, the main cause of most crash injuries is a rapid decrease in speed when an occupant strikes hard parts inside a vehicle.

To understand this concept, it helps to remember that people inside a car travel at the same speed as the car. If your car crashes into a solid barrier at 30 mph, for example, it will come to a stop almost instantly. But you and anyone else in the car will continue moving forward at 30 mph until you are slowed or stopped by something.

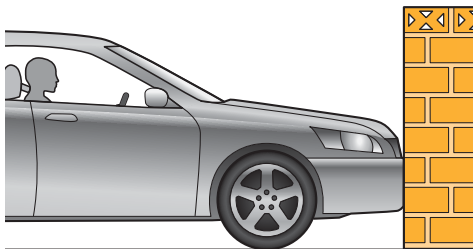

In a 30-mph, head-on crash into a barrier, a vehicle decelerates to a stop in about 1/10th of a second, less than the blink of an eye. What happens to an occupant during this time?

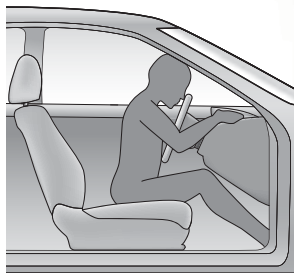

Without a seat belt or an airbag, the occupant will continue forward at 30 mph until they strike the interior of the car with enough force to cause serious injuries.

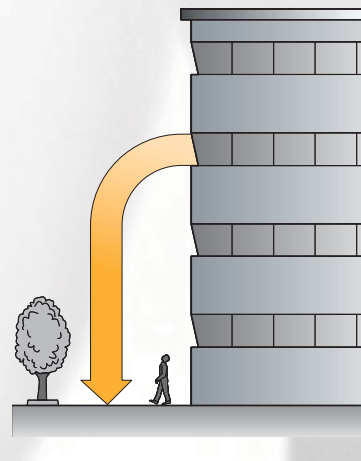

The force that would be experienced by an unbelted driver or passenger striking interior vehicle parts would be equal to the force of falling out of a third-story window onto the ground.

## HOW YOUR VEHICLE IS DESIGNED TO HELP PROTECT YOU IN A CRASH

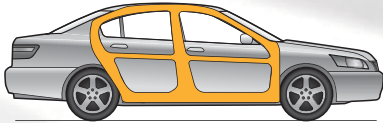

A strong metal frame forms a safety cage around the occupants. Side impact bars across the doors provide additional protection.



Our unique ACE™ structure provides superior energy management in frontal crashes between differently sized vehicles.

**OVER THE YEARS,** Honda and Acura engineers have continually found new ways to help occupants survive the tremendous forces that can occur in a crash.

All our vehicles have a strong metal framework that either completely surrounds the occupants or, in the case of our convertibles, provides sturdy rollover bars. Most

also have energy-absorbing crush zones, and many have an ACE™ (advanced compatibility engineering) structure to help control crash energy in frontal collisions between vehicles of different sizes.

All newer Honda and Acura cars and trucks have front and side airbags, and all except convertibles have side curtain airbags as well. But you can't take full advantage of these and other safety equipment unless you and your passengers wear seat belts and wear them properly.

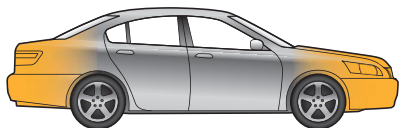

Crushable body parts are designed to absorb crash energy during front and rear-end collisions.

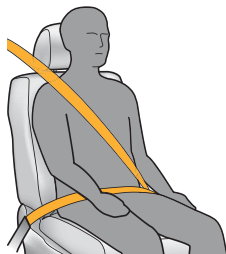

Properly positioned seat belts help restrain occupants and keep them in position in every type of crash.



Head restraints help protect the neck and upper spine during rear-end crashes.

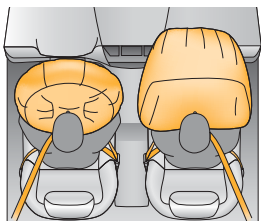

Front airbags supplement seat belts to help protect the head and chest of the driver and passenger in front.

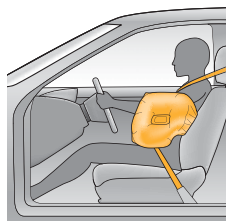

Side airbags can help reduce chest injuries to front-seat occupants during severe side impacts.

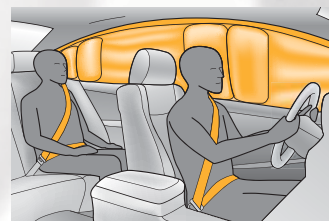

Side curtain airbags can help protect the heads of outboard occupants during a side impact.

**IN ADDITION TO HELPING** protect occupants *during a crash*, our engineers have devised systems to help drivers *avoid a crash*.

**Antilock Braking System (ABS):**

Without ABS, if a driver slams on the brakes, the wheels can lock, causing skidding and/or a loss of steering control. With ABS, if sensors detect that a wheel has stopped turning, the system automatically starts regulating the amount of braking pressure, which can help the driver maintain better control, possibly allowing him to stop in a shorter distance on wet or icy roads, or steer away from a crash.

**Electronic Brake Distribution (EBD):**

The EBD system has sensors that closely monitor individual wheel speeds during braking. The system uses this information to determine how much braking pressure to deliver to each wheel, which results in maximum braking effectiveness under most load conditions.

**Vehicle Stability Assist (VSA):** During a turn, VSA uses various types of sensors to determine if the front wheels are about to plow forward and/or the rear wheels are about to skid outward. Depending on the situation, VSA can regulate the amount of engine power



and/or the amount of braking at each wheel to help the driver maintain traction and directional control.

**Brake Assist:** This system is designed to help drivers maximize braking power in a panic situation. Each time a vehicle equipped with brake assist is started, the system begins analyzing how much time and pressure the driver normally uses when braking. Then, if the driver steps on the pedal harder and faster than normal, the system will apply maximum braking until the vehicle comes to a stop or the driver releases the brakes.

### **Collision Mitigation Braking System**

**(CMBS):** The purpose of this system is to prevent or reduce the severity of a crash into the rear of a vehicle in the lane ahead. The system uses radar to monitor the relative distance between the two vehicles. If the distance stays the same or increases, the system takes no action.

However, if the distance between the vehicles decreases, the system will alert the driver of the CMBS-equipped vehicle with a beeping sound and a flashing light. If the driver fails to slow down, the system will tug on the driver's seat belt and begin light braking. Should the

driver still fail to slow down, the system will tighten both front seat belts and brake very hard. Also, if the distance between the vehicles decreases too rapidly, the system will immediately apply maximum braking while alerting the driver and tightening the front seat belts.

## HOW SEAT BELTS & AIRBAGS CAN HELP PROTECT YOU IN A FRONTAL CRASH

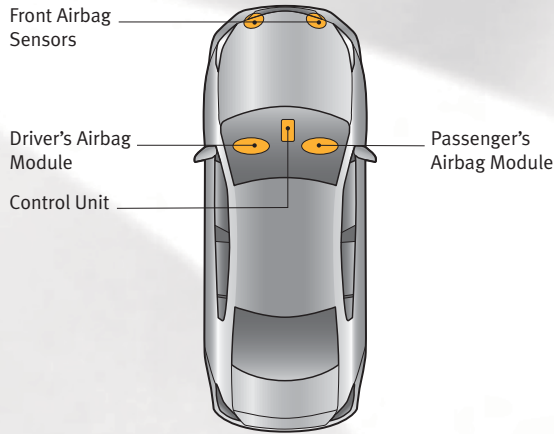

A sophisticated electronic system monitors all airbag systems and the front seat belts whenever the ignition switch is in the ON position. An indicator alerts the driver if a possible problem is detected.

**IF YOU EVER** have a frontal crash with another vehicle or a solid object, such as a concrete wall or bridge support, sensors will detect the vehicle's sudden deceleration and send that information to the control unit.

If the rate of slowing is high enough, the control unit will signal tensioners to instantly tighten the front seat belts. At the same time, the control unit will signal inflators in the front

airbag modules to ignite and fill the bags with nitrogen, a harmless gas.

While the seat belt (your primary restraint) keeps you connected to the seat, the front airbag (your supplementary restraint) helps slows down your forward movement and reduces the risk of your head and chest directly striking hard interior parts.



In a moderate-to-severe frontal crash, the seat belts lock to restrain the occupants, and tensioners tighten the front seat belts.



Front airbags help slow occupants' forward movement and have been proven very helpful in reducing serious head and chest injuries.

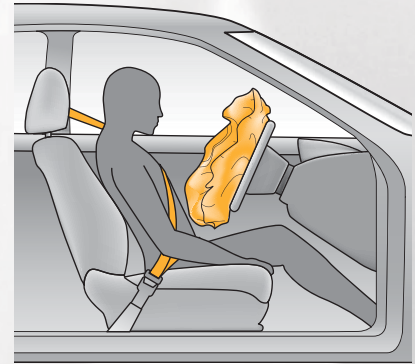

Front airbags inflate and deflate in a fraction of a second, so fast that many people do not realize their airbag deployed until they see it in front of them.

## DUAL-STAGE, DUAL-THRESHOLD, ADVANCED FRONT AIRBAGS

**SINCE THE FIRST AIRBAGS** were installed in the 1980s, front airbags have been greatly improved. Instead of operating exactly the same in any frontal crash, they now function differently, depending on: (1) the severity of the crash, (2) whether an occupant is belted or not, (3) how far the driver is seated from the steering wheel, and (4) the presence and size of a passenger riding in front.

**Dual-Stage Airbags:** To tailor front airbag deployment to the severity of a crash, airbag modules now have two inflators instead of one. In a severe crash, the two ignite together for the fastest protection. In a less severe crash, they ignite sequentially for a longer and less forceful deployment.

**Dual-Threshold Airbags:** Front airbags have always been intended as a supplementary restraint system (SRS), to augment an occupant's primary restraint—the seat belt. Since an unbelted occupant needs extra protection, their airbag will inflate at full force and in a less severe collision than if they were wearing their seat belt.

**Advanced Airbags:** Both front airbags now have “advanced” features. To help prevent airbag-caused injuries to shorter drivers, the driver’s bag will inflate with the least force necessary—even in a severe collision—if the driver is seated closer to the airbag than recommended.

To prevent airbag-caused injuries to infants and small children improperly placed in front, if sensors detect the weight on the seat is about the weight of an infant or small child in a child safety seat, the passenger’s front airbag will automatically shut off.



If the driver's seat position sensor detects a driver is closer to the steering wheel than recommended, the airbag will inflate with the least force possible.



If sensors detect up to about 67 lbs (the weight of an infant or small child) on the front passenger's seat, the airbag will automatically turn off.

## WHEN FRONT AIRBAGS CAN HELP PROTECT YOU

**FROM THE FIRST TIME** airbags were installed in passenger vehicles, front airbags have had a very simple but important role: To reduce the severity of head and chest injuries that can occur to a driver and front-seat passenger in a moderate-to-severe frontal collision.

A frontal collision can be either head-on or angled between two vehicles, or when a vehicle crashes into a stationary object, such as a concrete wall.

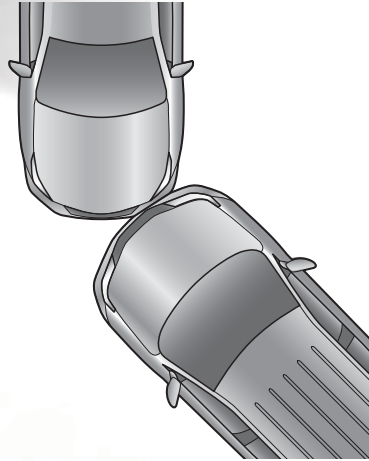

Front airbags are designed to supplement the restraint provided by seat belts in a moderate-to-severe frontal collision with another vehicle.

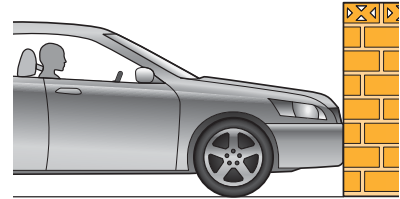

Front airbags can also help protect the heads and chests of front seat occupants if a vehicle crashes into a large stationary object.

**FRONT AIRBAGS** cannot be helpful, and should not deploy, in the following situations:

**Minor Frontal Crashes:** Front airbags were designed to supplement seat belts and help save lives, not to prevent minor scrapes, or even broken bones, that might occur during a less than moderate-to-severe frontal crash.

**Side Impacts:** Side airbags and side curtain airbags have been specifically designed to help reduce the severity of injuries that can occur during a moderate-to-severe side impact.

**Rear Impacts:** Head restraints and seat belts are your best protection during a rear impact. Front airbags cannot provide any significant protection and are not designed to deploy in such collisions.

**Rollovers:** Seat belts, side airbags, and side curtain airbags offer the best protection in a rollover. Because front airbags could provide little if any protection, they are not designed to deploy during a rollover.

## HOW SIDE AIRBAGS & SIDE CURTAIN AIRBAGS HELP PROTECT YOU

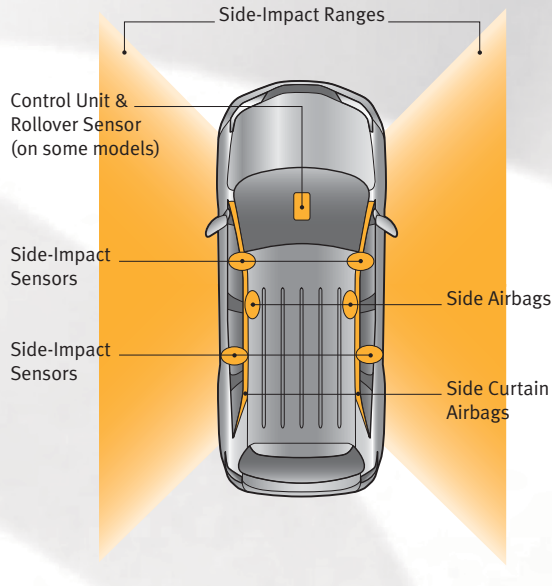

On average, side impacts account for about one-fourth of all crash fatalities.

**Side Airbags:** During a side impact, sensors detect the crash and send information to the control unit. If the impact is severe enough, the control unit signals the driver's or the front passenger's side airbag to instantly inflate into the space between the door and the occupant.

**Side Curtain Airbags:** In a crash severe enough to inflate a side airbag, the side curtain airbag on the impact side will also inflate. This airbag helps prevent the heads of outboard occupants from striking the vehicle's windows and structural beams.

In some models (e.g., SUVs and minivans), both side curtain airbags will deploy if the vehicle rolls over.





Side airbags are designed to help protect a front occupant's chest.

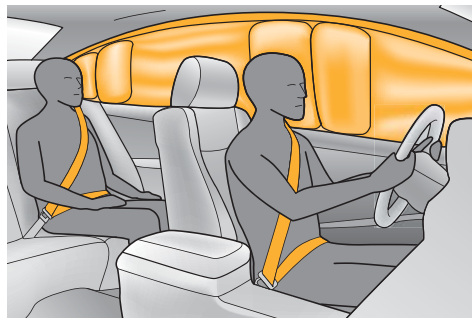

Side curtain airbags, stored above the windows, help protect the heads of occupants seated next to them.

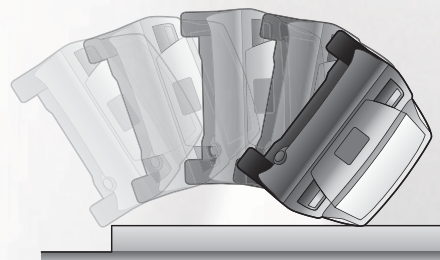

In certain vehicle models, both side curtain airbags should inflate if the vehicle ever rolls over.

## HOW YOU CAN BE HURT & WHAT CAN HELP PROTECT YOU IN A REAR-END CRASH

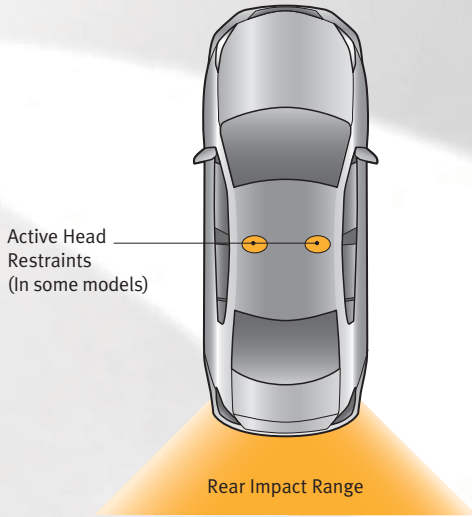

Rear impacts are rarely deadly, but they account for about one-fourth of all non-fatal injuries.

**WHEN ONE VEHICLE CRASHES** into the rear of another, the one in front is suddenly accelerated forward. Even if the impact is moderate, an occupant in the front vehicle can feel like their body is pushed strongly back in the seat. Their head may follow with a jerking motion that can result in painful “whiplash” injuries to the neck and upper spine.

To reduce the severity of such injuries, all newer vehicles have a head restraint at each seating position. Some models even have “active” head restraints for the driver and a front-seat passenger. During a moderate-to-severe rear impact, an active restraint moves up and forward to reduce the distance between the restraint and the occupant’s head.



---

Adjusting a head restraint so the center is level with the back of the occupant's head (or as high as possible for taller people) can help reduce injuries during a rear impact.



---

In vehicles equipped with active head restraints, the restraint will move up and forward a little when enough pressure is applied against the seat-back.

## HOW TO PROTECT YOURSELF AND OTHER ADULT OR TEENAGE PASSENGERS

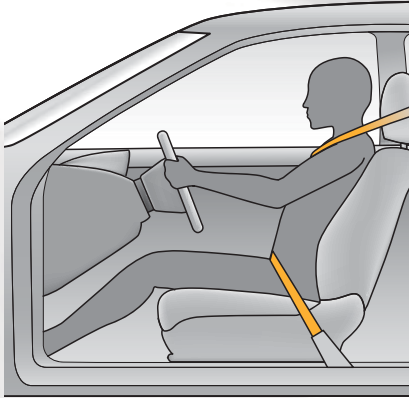

Wearing a seat belt properly and sitting upright helps reduce the chance of serious injuries in all types of collisions. It also helps keep occupants connected to the car and in the best position if the front, side, or side curtain airbags deploy.

- 1. Always** wear a seat belt properly, with the lap part snug across your hips and the shoulder part over your shoulder and against your chest.
- 2. Move** the driver's seat as far back as possible while still allowing good vehicle control, and have a front passenger adjust their seat as far to the rear as possible.
- 3. Adjust** the head restraints, if possible, so the center of a restraint is level with the back of the occupant's head. If a taller person cannot raise the restraint that high, it should be raised to the highest position.
- 4. Sit up** straight with the seat-back upright, and maintain this position throughout a ride.

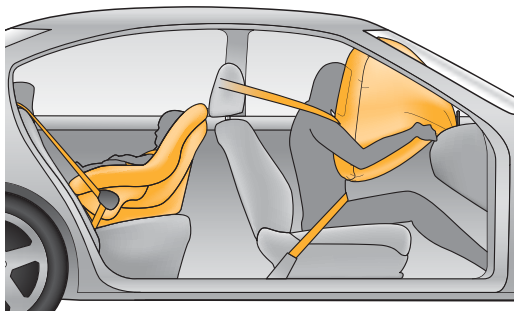

Never install a rear-facing child seat in the front seat. In a severe frontal collision, or if the passenger's front airbag deploys, the child could be killed or seriously injured.

**FROM BIRTH** until about one year of age, an infant should be restrained in a rear-facing, reclining child seat that is properly secured in a rear seating position. Never place an infant in the front. Even if the advanced front passenger's airbag system turns the front passenger's airbag off, a rear seating position is far safer.

See your owner's manual and the child seat maker's instructions for how to properly install a child seat. And remember, it's also very important to make sure the infant is properly secured in the safety seat.

## HOW TO PROTECT OLDER CHILDREN WHO RIDE IN YOUR CAR

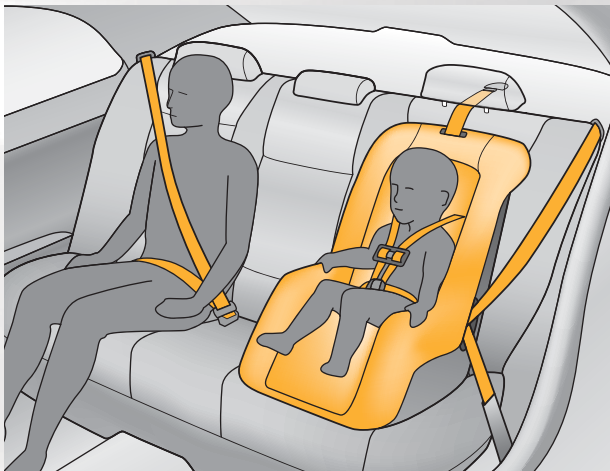

Children age 12 and under should ride properly restrained in a back seat, not in the front.

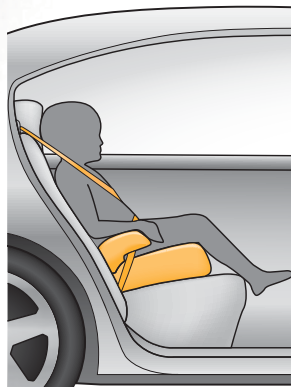

A child who outgrows a forward-facing child seat should use a booster until the child is large enough for the seat belt to fit properly without a booster seat.

### THE NATIONAL HIGHWAY

Traffic Safety Administration (NHTSA) and all car makers strongly recommend that children age 12 and under ride properly restrained in a back seat, not in the front.

A child who grows out of an infant seat should be restrained in a forward-facing safety seat until they reach the seat maker's height or weight limit. The child should then ride on a booster seat with the seat belt properly positioned until the child can use the belt without it touching the child's neck.

**Q: If a vehicle appears badly damaged after a crash, does this mean the airbags should have deployed?**

Not necessarily. It is extremely difficult to accurately determine whether one or more airbags should have deployed based only on visual damage.

After a frontal crash, extensive damage to crushable body parts often indicates that the vehicle absorbed crash energy and reduced the rate of deceleration to a level where the front airbags would not have been needed or helpful.

Side impacts, particularly when both vehicles are moving in the same direction, can cause widespread superficial damage without causing the side airbag and side curtain airbag to deploy.

**Q: Can airbags prevent crash injuries?**

Unfortunately, no safety system or combination of systems can provide complete protection.

Front airbags are designed to save lives and reduce the severity of injuries to the heads and chests of front seat occupants during a frontal collision. Similarly, side airbags and side curtain airbags are designed to reduce the severity of injuries to occupants seated in outboard positions during a sufficiently severe side impact.

While airbags have proven to be effective, they cannot prevent all injuries. And some crashes are so severe that they result in very serious or fatal injuries—even when seat belts are properly worn and the airbags work as intended.

## QUESTIONS ABOUT YOUR CAR'S AIRBAGS AND OTHER SAFETY EQUIPMENT

**Q: What makes the Passenger Airbag Off indicator come on?**

Front airbags are designed to help protect adult and teenage occupants, not infants or small children. To do its job, the passenger's front airbag must inflate quickly and with a force that can kill or seriously injure an infant or small child.

Because of these risks, if sensors detect up to about 67 pounds—the approximate weight of an infant or child and their safety seat—the control unit

automatically shuts the airbag off, and the Passenger Airbag Off indicator comes on.

Of course, since the system can't actually "know" what is on the front passenger's seat, placing a package or other object can also make the indicator come on. In addition, if weight on the seat is close to the upper or lower threshold, the indicator may flicker on and off.

If the indicator comes on without any person or object on the seat, have the vehicle checked as soon as possible.

**Q: Why does an indicator sometimes come on saying Side Airbag Off?**

Your vehicle has a side airbag cutoff system in the front passenger's seat. (The system is sometimes referred to as the Occupant Position Detection System, or OPDS.) This system can determine whether a child or short adult may be



riding in the seat, and whether the passenger is sitting upright or has leaned sideways into the side airbag's deployment path.

To prevent the side airbag from deploying and possibly injuring the occupant, the system automatically turns the side airbag off. When the passenger returns to a correct upright position, the control unit turns the side airbag on again.

**Q:**

**What's the best way to secure a child safety seat to a vehicle— with a seat belt or with LATCH?**

Tests have shown that a child seat is equally secure if it has been properly installed with a seat belt or using a relatively new system called Lower Anchors and Tethers for Children (LATCH). The key word, of course, is “properly.”

Most parents, grandparents, and other caregivers find it is easier to use LATCH. But it's very important to make sure that the top tether strap on a LATCH-compatible forward-facing child seat is always installed and tightened, and you don't rely on the lower anchors do all the “work.”

Whether you use the seat belt or the LATCH system, it's important to carefully follow the child-seat maker's instructions as well as those in your owner's manual. And don't forget to give the child seat a good rocking to make sure it is secure.

**Q: Are there any other special tips on protecting children who ride in my car?**

Here's a few:

- Using childproof door locks will prevent a child in a back seat from opening a door when it isn't safe to do so.
- Locking the windows can prevent children from playing with the controls and accidentally hurting their own or someone else's fingers.
- Don't let a child put the shoulder part of a seat belt behind their back or under their arm. This could cause serious injuries in a crash.
- Be sure any unused seat belt that a child can reach is buckled, pulled all the way out so the retractor is activated, then fully retracted. This will prevent a child from playing with the belt, putting it around their neck and possibly being strangled.
- Never, ever let a child 12 or under ride in front.



